

The BANDO logo is located in the top right corner. It consists of the word "BANDO" in a bold, black, sans-serif font, centered between two horizontal lines. The top line is red, and the bottom line is black. The background of the entire advertisement is a collage of images: a large pile of grey crushed stone, a blue truck with an orange conveyor belt attachment, and a white truck with a worker in a high-visibility vest.

POWER ACE[®] ARAMID V-BELTS SINGLES & COMBO

NEW

High-modulus/low-elongation
aramid cord

50% or higher
breaking strength

40% or higher
transmission capacity

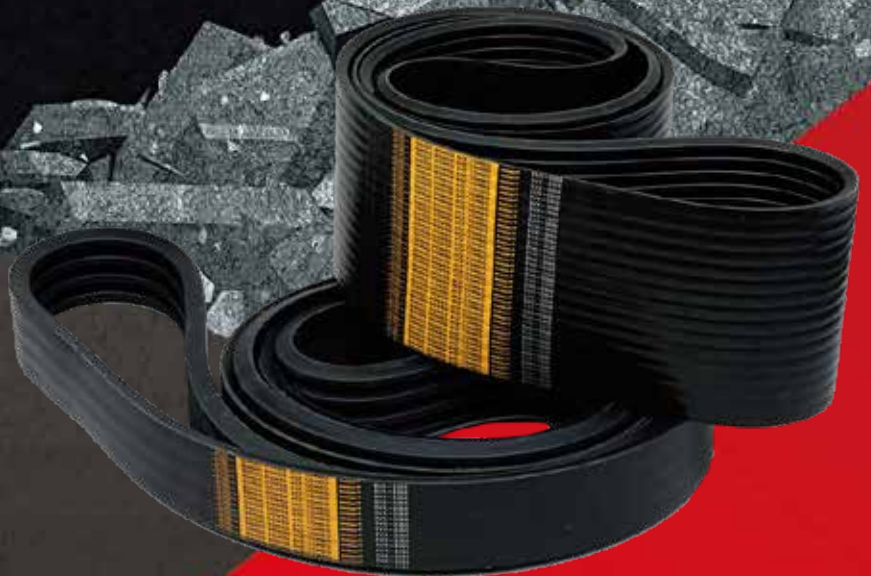

POWER ACE®

ARAMID V-BELTS

SINGLES & COMBO

Power Ace® Aramid belts are constructed with high modulus aramid cords to maintain length stability and to withstand severe shock loads, making them ideally suited for oil, gas, aggregate and lumber industry applications. Meets ARPM standards for heat resistance and static conductivity.

BAN/SET®

*System eliminates matching requirements.

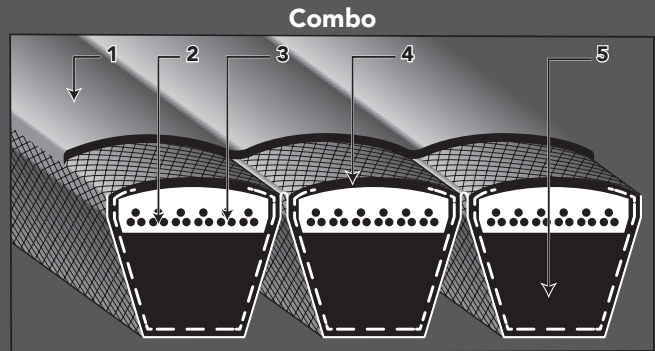
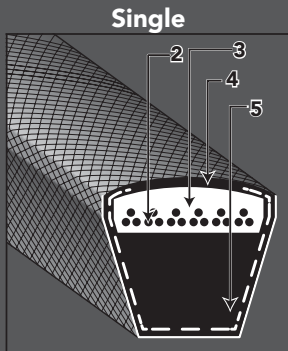

1. Tie band on Combo belts: New construction delivers excellent anti-abrasion performance and adhesion, leading to increased service life.
2. High-modulus aramid cords: Increase the breaking strength by more than 50% compared to polyester cord V-belts. 40% higher transmission capacity than polyester V-belts.
3. Banprene® adhesion rubber.
4. Rubber impregnated canvas: Belts are static conductive per ARPM bulletin IP3-3.
5. Banprene® compression rubber provides premium cord support and sheave sidewall contact.

Single and Combo belts are *Banset® matched.

Part Number Example

8VK 1250
 ———— Belt Size (Effective Outside Length) 125 inches
 ———— Belt Section

Nominal Dimension



| Single Sizes | | | |
|--------------|----------------------|-------------------|-------------|
| Belt Section | Top Width W (Inches) | Height H (Inches) | Size Range |
| 5VK | 0.62 | 0.54 | 600 - 3550 |
| 8VK | 1.0 | 0.88 | 1060 - 5600 |

Part Number Example

3 - 8VK 1250
 ———— Belt Size (Effective Outside Length) 125 inches
 ———— Belt Section
 ———— Number of ribs

Nominal Dimension

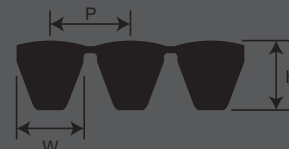

| Combo Sizes | | | | |
|--------------|----------------------|-------------------|--------------------------------|-------------|
| Belt Section | Top Width W (Inches) | Height H (Inches) | Pitch Between Belts P (Inches) | Size Range |
| 5VK | 0.62 | 0.63 | 0.69 | 600 - 3550 |
| 8VK | 1.0 | 0.98 | 1.13 | 1060 - 5600 |



TRANSMISSION CAPACITY

Excessive Load Test for Service Life

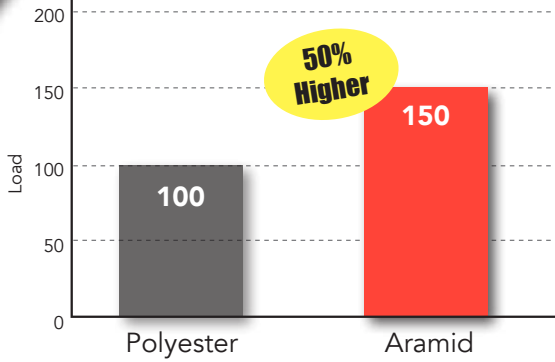

Strength Test

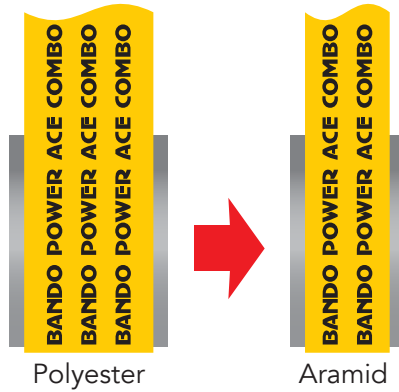
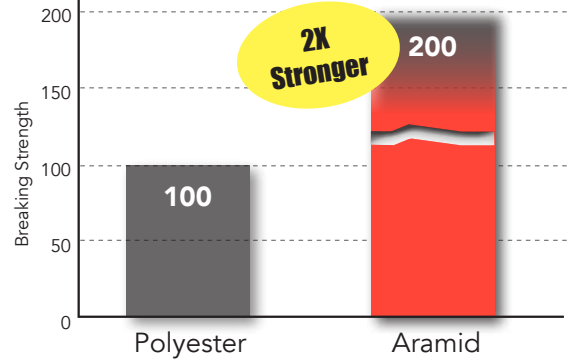

Drives can be designed utilizing fewer ribs, reducing design weight.

Field Test Result of Service Lifetime

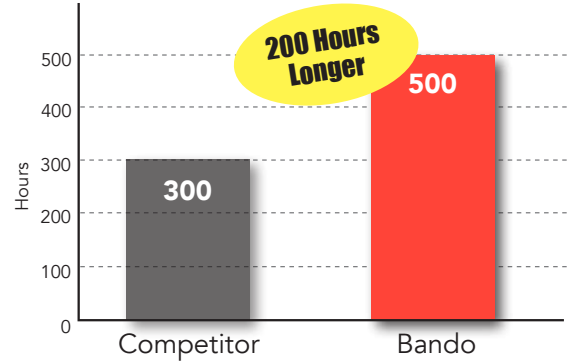

Service lifetime tested longer than our competitor during field testing on pavement milling machines.

Basic Horsepower Comparison (5VK)

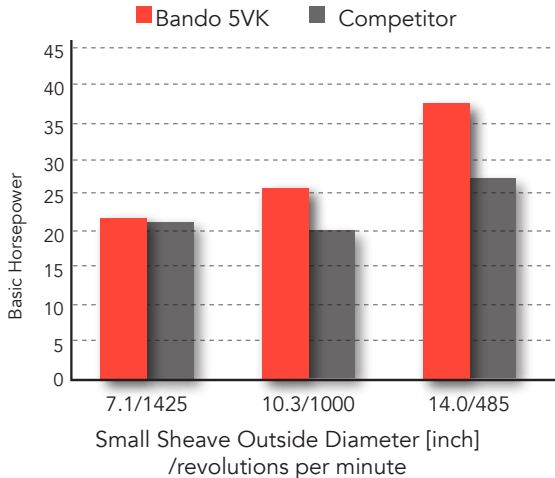

Basic Horsepower Comparison (8VK)

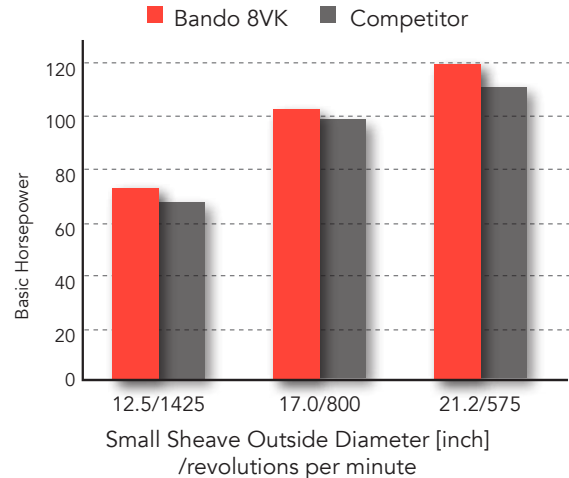

Shock-Load Absorbing, Power Ace® Aramid Single & Combo V-Belts

Especially suitable for high shock-load applications, such as pavement milling or wood chippers. Service lifetime is longer than other leading manufacturers based on field testing.

| 5 VK SINGLES | | | |
|--------------|-----------------------------------|-------------|-----------------------------------|
| Part Number | Effective Outside Length (Inches) | Part Number | Effective Outside Length (Inches) |
| 5VK800 | 80.0 | 5VK1700 | 170.0 |
| 5VK850 | 85.0 | 5VK1800 | 180.0 |
| 5VK900 | 90.0 | 5VK1900 | 190.0 |
| 5VK950 | 95.0 | 5VK2000 | 200.0 |
| 5VK1000 | 100.0 | 5VK2120 | 212.0 |
| 5VK1060 | 106.0 | 5VK2240 | 224.0 |
| 5VK1120 | 112.0 | 5VK2360 | 236.0 |
| 5VK1180 | 118.0 | 5VK2500 | 250.0 |
| 5VK1250 | 125.0 | 5VK2650 | 265.0 |
| 5VK1320 | 132.0 | 5VK2800 | 280.0 |
| 5VK1400 | 140.0 | 5VK3000 | 300.0 |
| 5VK1500 | 150.0 | 5VK3150 | 315.0 |
| 5VK1600 | 160.0 | 5VK3350 | 335.0 |

| 8 VK SINGLES | | | |
|--------------|-----------------------------------|-------------|-----------------------------------|
| Part Number | Effective Outside Length (Inches) | Part Number | Effective Outside Length (Inches) |
| 8VK1400 | 140.0 | 8VK2360 | 236.0 |
| 8VK1500 | 150.0 | 8VK2500 | 250.0 |
| 8VK1600 | 160.0 | 8VK2650 | 265.0 |
| 8VK1700 | 170.0 | 8VK2800 | 280.0 |
| 8VK1800 | 180.0 | 8VK3000 | 300.0 |
| 8VK1900 | 190.0 | 8VK3150 | 315.0 |
| 8VK2000 | 200.0 | 8VK3350 | 335.0 |
| 8VK2120 | 212.0 | 8VK3550 | 355.0 |
| 8VK2240 | 224.0 | | |

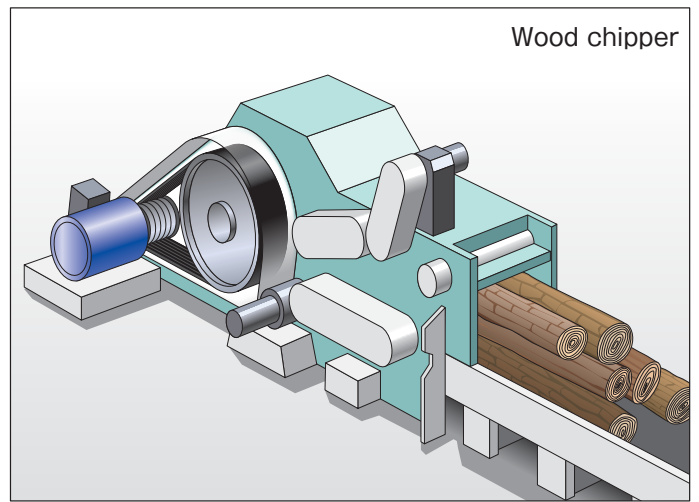
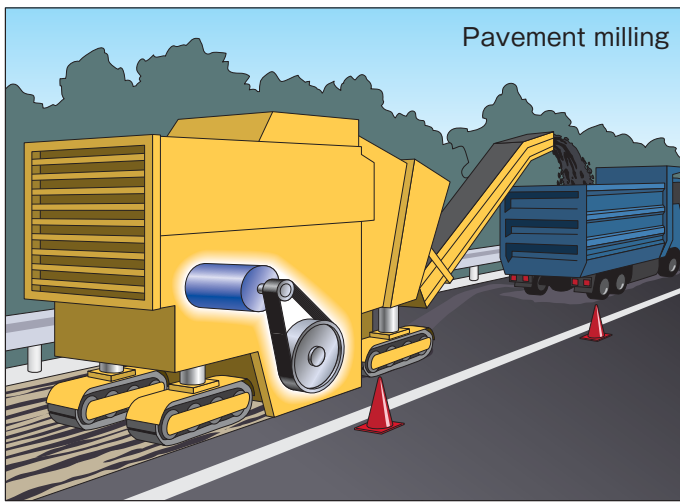

| 5 VK COMBOS | | | |
|-------------|-----------------------------------|-------------|-----------------------------------|
| Part Number | Effective Outside Length (Inches) | Part Number | Effective Outside Length (Inches) |
| 5VK600 | 60.0 | 5VK1500 | 150.0 |
| 5VK630 | 63.0 | 5VK1600 | 160.0 |
| 5VK670 | 67.0 | 5VK1620 | 162.0 |
| 5VK710 | 71.0 | 5VK1700 | 170.0 |
| 5VK750 | 75.0 | 5VK1800 | 180.0 |
| 5VK760 | 76.0 | 5VK1900 | 190.0 |
| 5VK800 | 80.0 | 5VK1920 | 192.0 |
| 5VK850 | 85.0 | 5VK1955 | 195.5 |
| 5VK860 | 86.0 | 5VK2000 | 200.0 |
| 5VK900 | 90.0 | 5VK2080 | 208.0 |
| 5VK920 | 92.0 | 5VK2120 | 212.0 |
| 5VK950 | 95.0 | 5VK2150 | 215.0 |
| 5VK960 | 96.0 | 5VK2200 | 220.0 |
| 5VK970 | 97.0 | 5VK2240 | 224.0 |
| 5VK1000 | 100.0 | 5VK2360 | 236.0 |
| 5VK1060 | 106.0 | 5VK2500 | 250.0 |
| 5VK1120 | 112.0 | 5VK2650 | 265.0 |
| 5VK1180 | 118.0 | 5VK2800 | 280.0 |
| 5VK1250 | 125.0 | 5VK3000 | 300.0 |
| 5VK1280 | 128.0 | 5VK3150 | 315.0 |
| 5VK1320 | 132.0 | 5VK3350 | 335.0 |
| 5VK1400 | 140.0 | 5VK3550 | 355.0 |
| 5VK1460 | 146.0 | | |

| 8 VK COMBOS | | | |
|-------------|-----------------------------------|-------------|-----------------------------------|
| Part Number | Effective Outside Length (Inches) | Part Number | Effective Outside Length (Inches) |
| 8VK1060 | 106.0 | 8VK2500 | 250.0 |
| 8VK1120 | 112.0 | 8VK2650 | 265.0 |
| 8VK1180 | 118.0 | 8VK2730 | 273.0 |
| 8VK1250 | 125.0 | 8VK2800 | 280.0 |
| 8VK1320 | 132.0 | 8VK3000 | 300.0 |
| 8VK1400 | 140.0 | 8VK3150 | 315.0 |
| 8VK1500 | 150.0 | 8VK3350 | 335.0 |
| 8VK1600 | 160.0 | 8VK3550 | 355.0 |
| 8VK1700 | 170.0 | 8VK3750 | 375.0 |
| 8VK1800 | 180.0 | 8VK4000 | 400.0 |
| 8VK1900 | 190.0 | 8VK4250 | 425.0 |
| 8VK2000 | 200.0 | 8VK4500 | 450.0 |
| 8VK2120 | 212.0 | 8VK4750 | 475.0 |
| 8VK2240 | 224.0 | 8VK5000 | 500.0 |
| 8VK2360 | 236.0 | 8VK5600 | 560.0 |



Available up to 10 ribs wide.

Available up to 16 ribs wide.

Please contact us for other size availability.

2nd Edition



@BandoUSAINc

BandoUSA.com

Customer Service: 800-829-6612

BandoUSA@bandogrp.com

BUI 1038/07-19

